

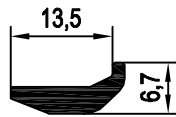

90812

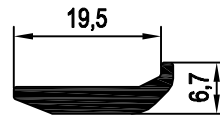

90813



150925

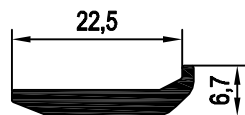

150926

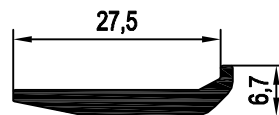

150927

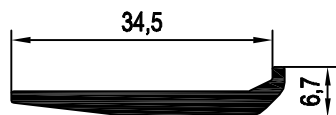

150909

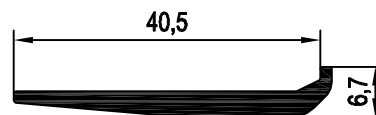

90804

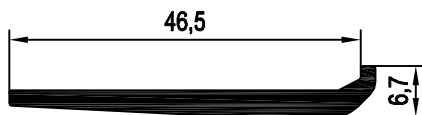

150928

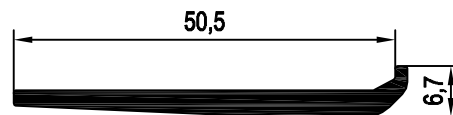

90814

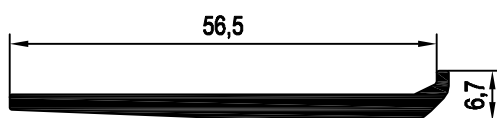

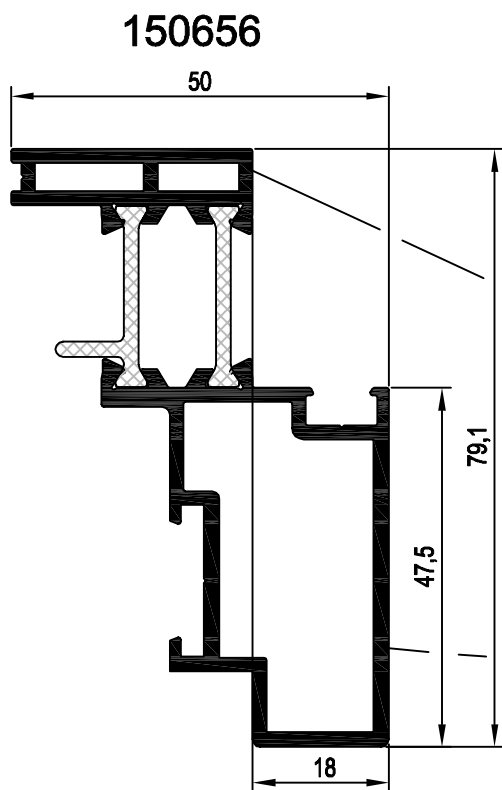

Внимание!
Алюминиевые составляющие профиля 150656
имеют требования к покрытию.

покрытие: анодное оксидирование

покрытие: покраска эмалью в цвет
по шкале RAL или анодное оксидирование

РН= 321.85 мм

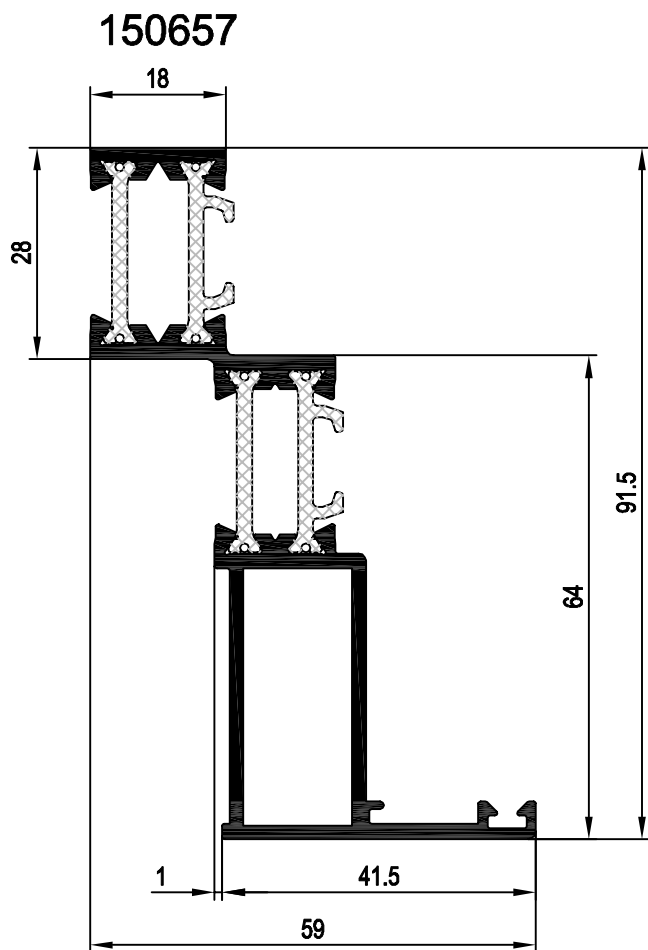

РН= 391.5 мм



150658

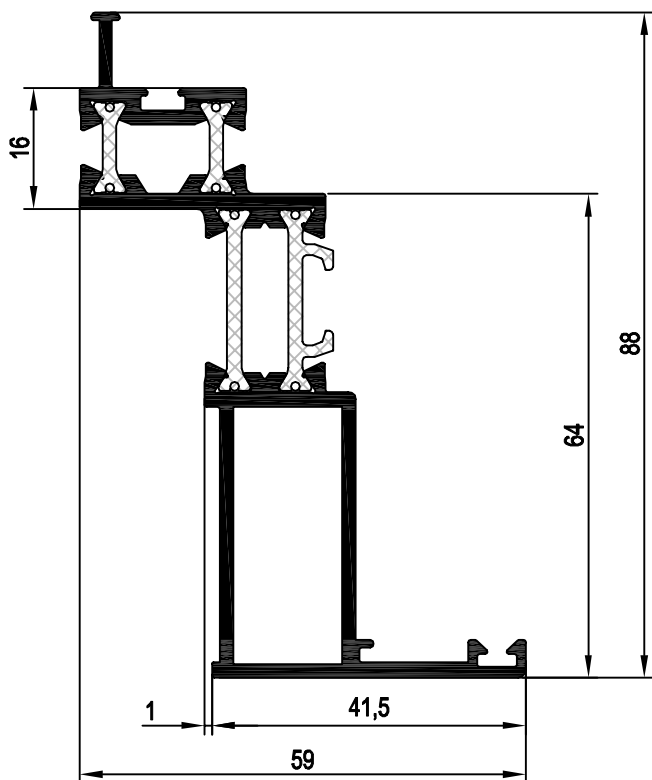

PH= 377.29 мм

150659

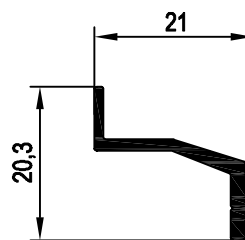

PH= 76.72 мм

150661

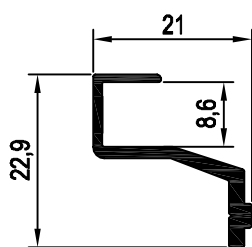

PH= 107 мм

150914

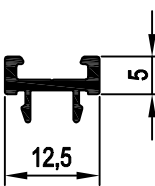

PH= 61 мм

001B

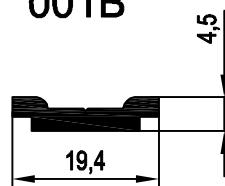

006B

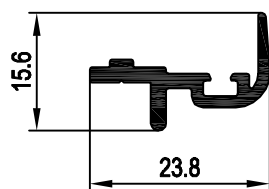

PH= 94.2 мм

150665

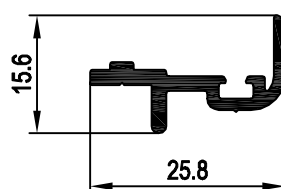

PH= 98.4 мм

150944

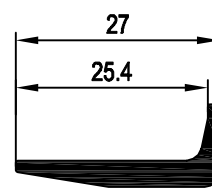



150663

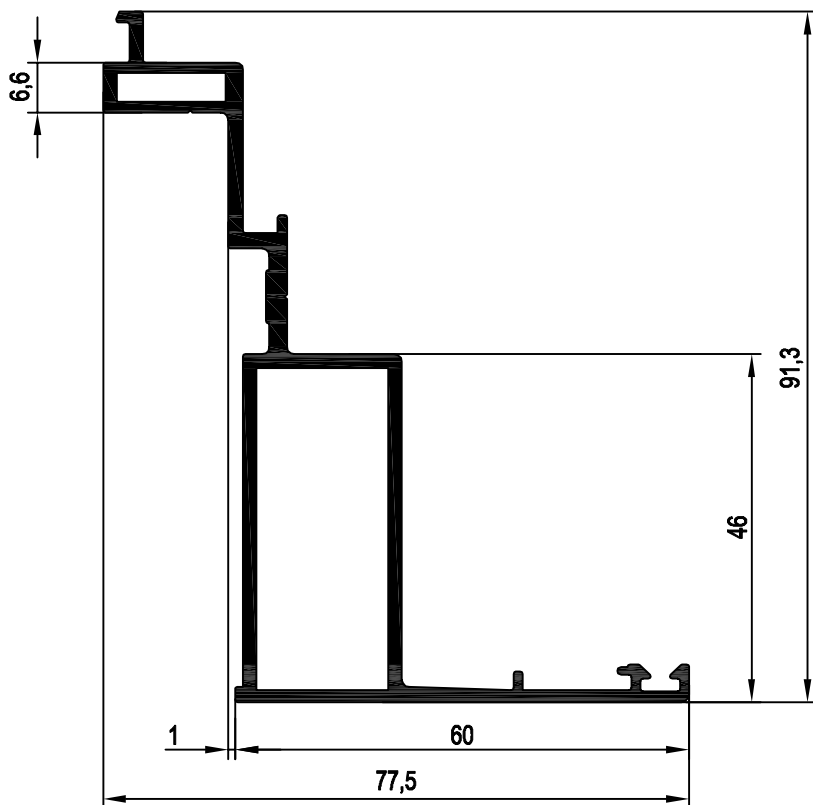

РН= 374.6 мм

150662

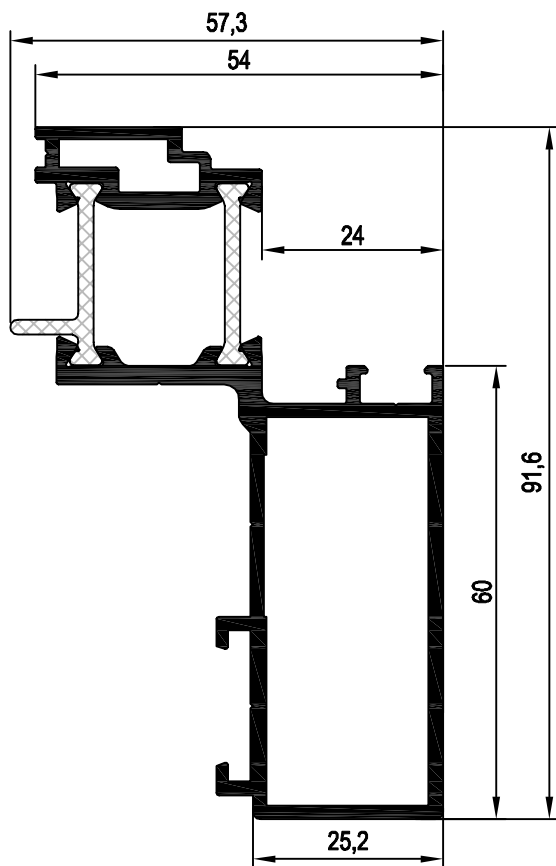

РН= 374.4 мм

150943

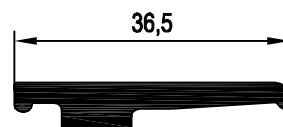

150945

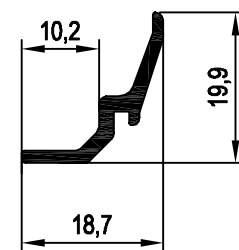

РН= 70 мм



150660



Внимание!
Алюминиевые составляющие профиля 150660 имеют требования к покрытию.

покрытие: анодное оксидирование

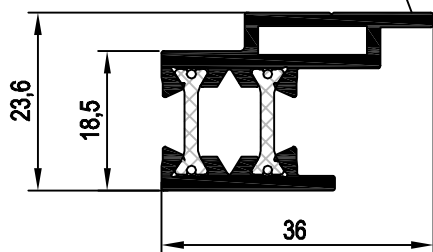

РН= 144,88 мм

150809

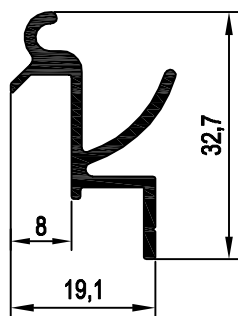

РН= 142,15 мм

150810

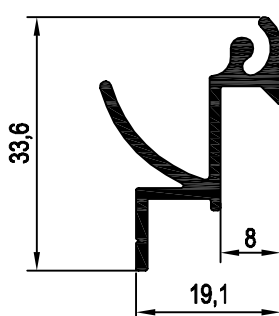

РН= 153,49 мм

150811

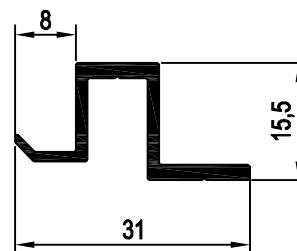

РН= 115,95 мм

150812

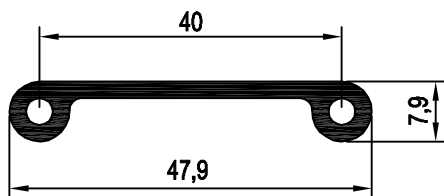

РН= 111,55 мм

150934

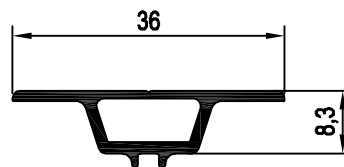

РН= 88,55 мм

150930

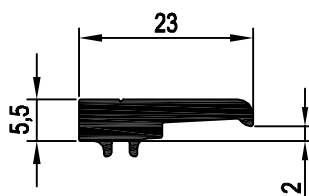

150932

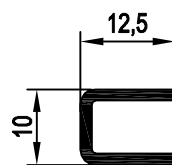

РН= 64,85 мм

150933

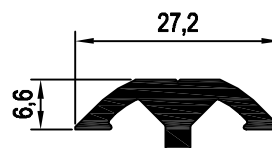

РН= 73,54 мм



АГРИСОВГАЗ

Система AGS 500