

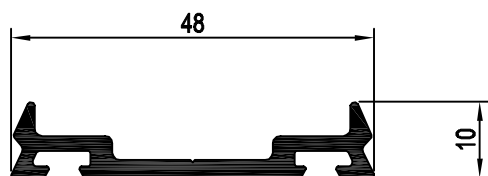

90400

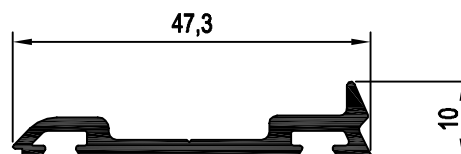

90401



90402

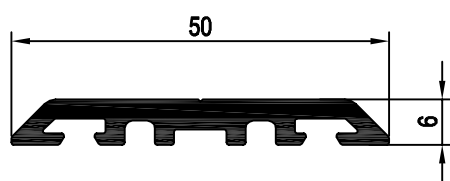

PH= 146.6 мм

90403

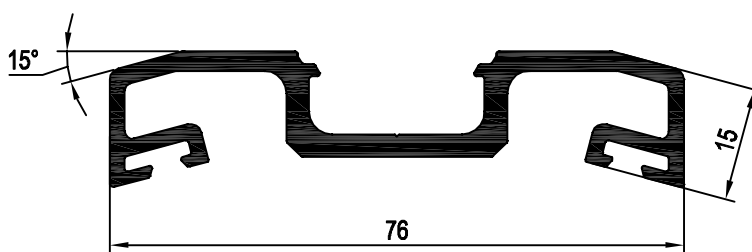

PH= 318.8 мм

90404

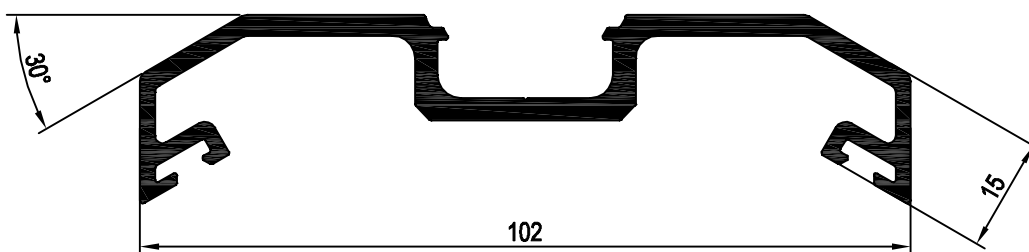

PH= 374.5 мм

90405

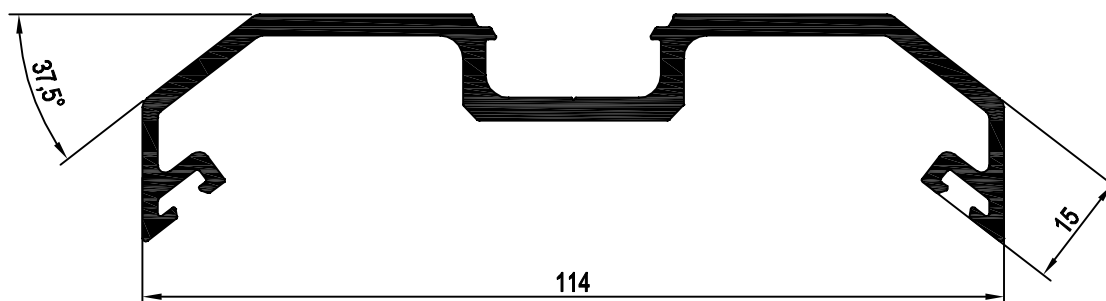

PH= 404.7 мм



90406

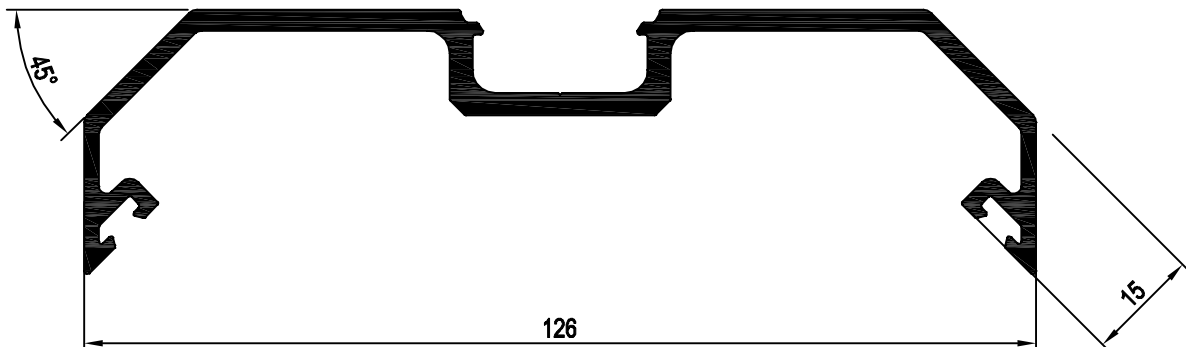

РН= 436.4 мм

150322

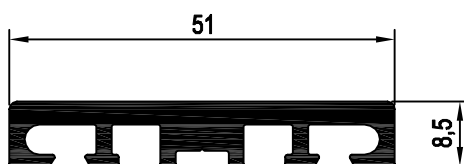

РН= 183.6 мм

150324

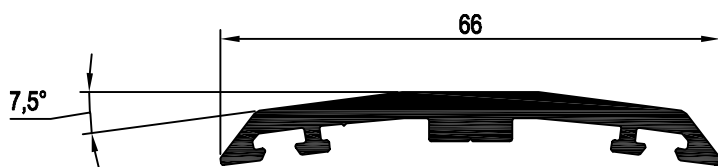

РН= 178.9 мм

150325

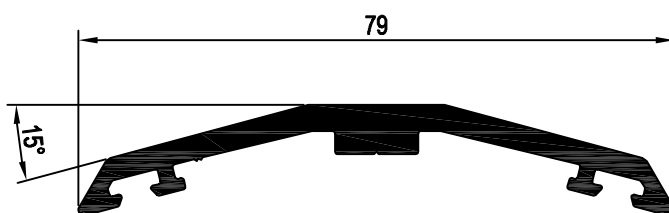

РН= 210.2 мм



90407

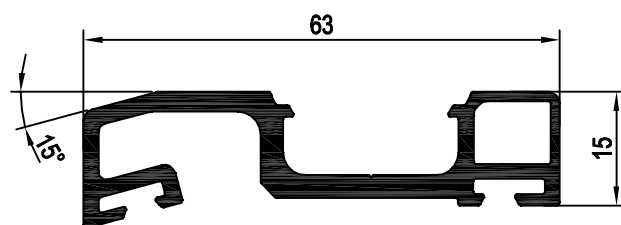

$R_H = 251.7$  мм

90408

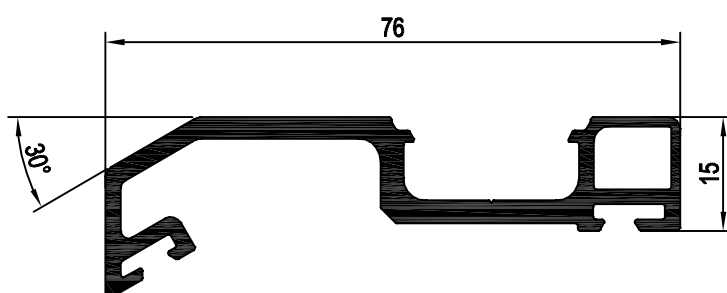

$R_H = 279$  мм

90409

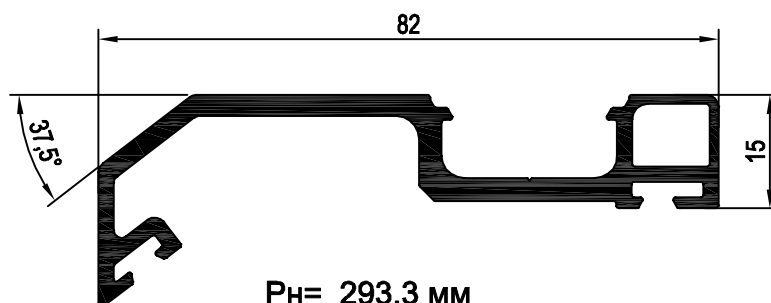

$R_H = 293.3$  мм

90410

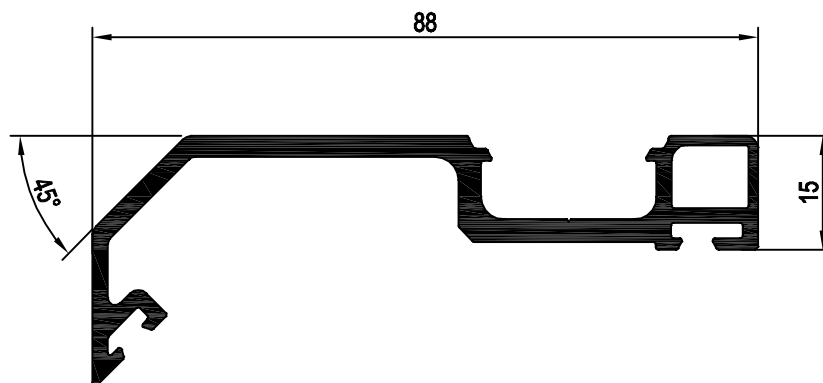

$R_H = 308.8$  мм



90411

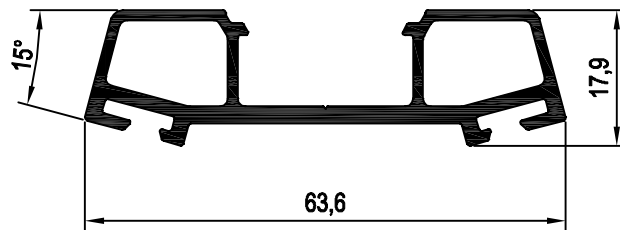

РН= 213.7 мм

90412

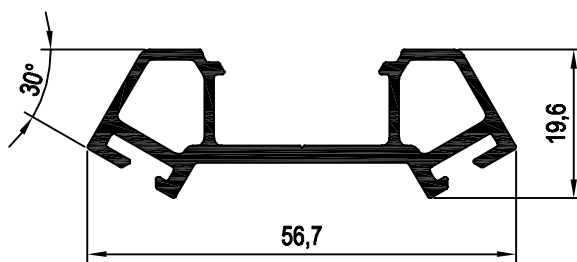

РН= 196.9 мм

90413

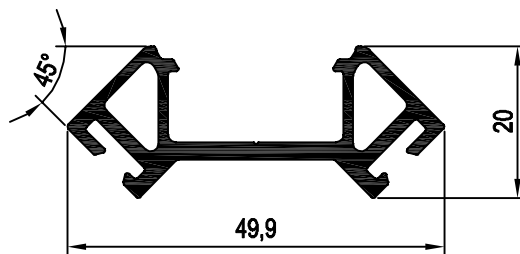

РН= 180.5 мм

90414

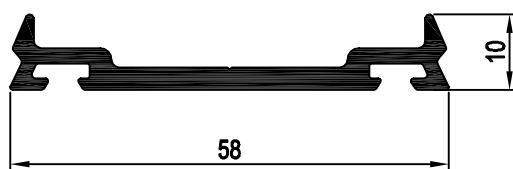



90415

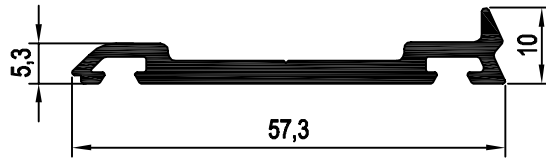

90416

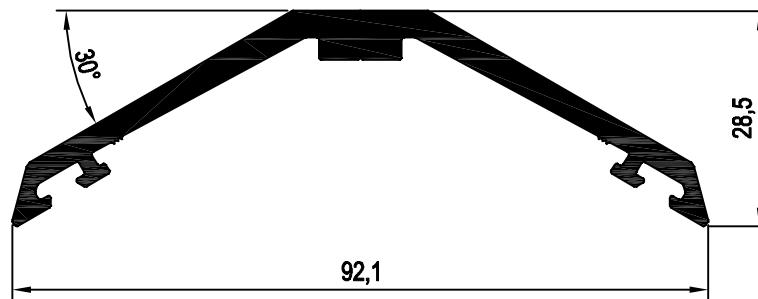

РН= 261 мм

90417

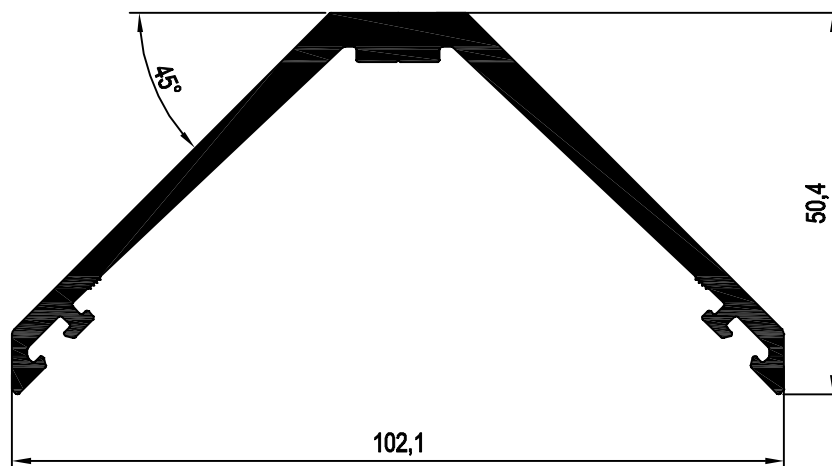

РН= 332.1 мм



90418

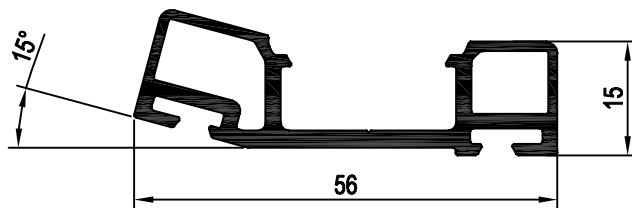

$R_H = 197.1 \text{ мм}$

90419

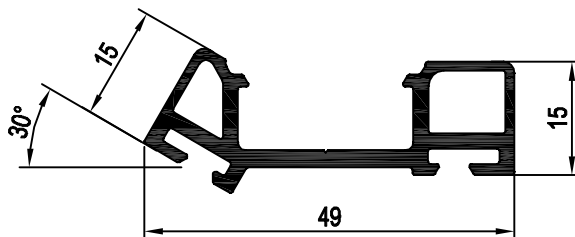

$R_H = 182.3 \text{ мм}$

90420

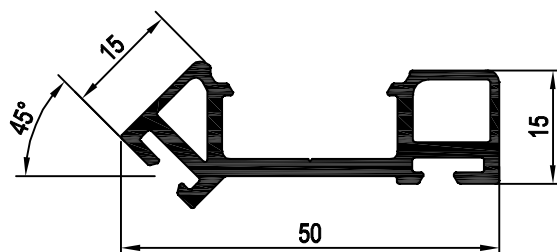

$R_H = 183.4 \text{ мм}$



**90500**

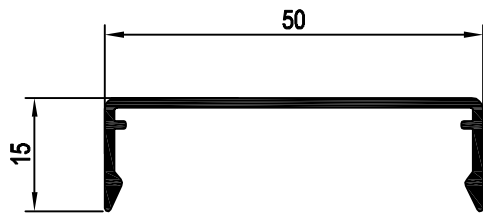

РН= 161 мм

**90501**

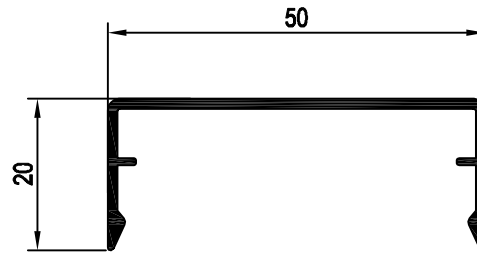

РН= 185 мм

**90502**

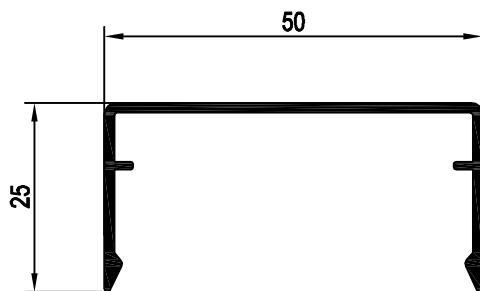

РН= 205 мм

**90503**

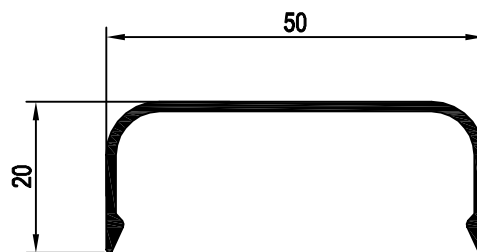

РН= 161 мм

**90504**

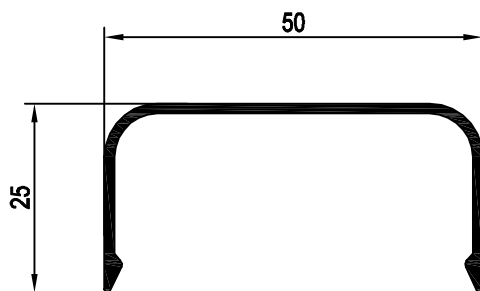

РН= 186 мм

**90505**

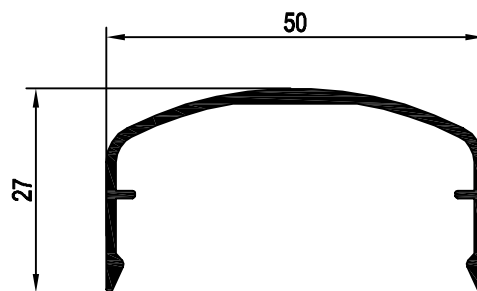

РН= 191.1 мм

**90506**

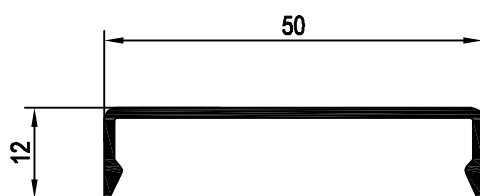

РН= 143.5 мм

**90507**

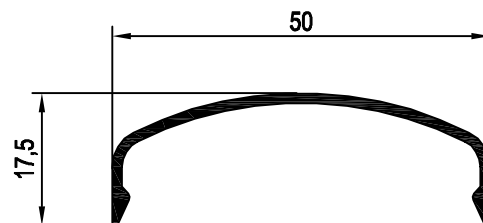

РН= 143.7 мм



90508

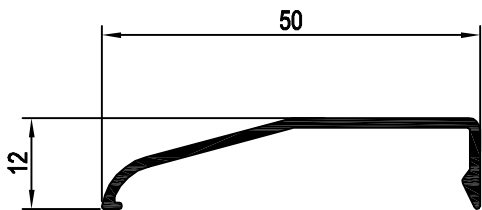

РН= 131.6 мм

90509

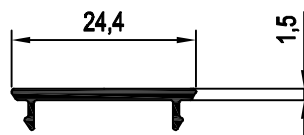

РН= 66 мм

90510

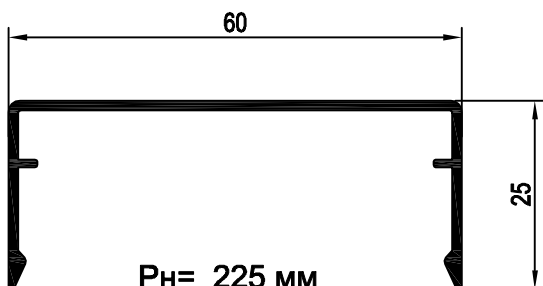

РН= 225 мм

90511

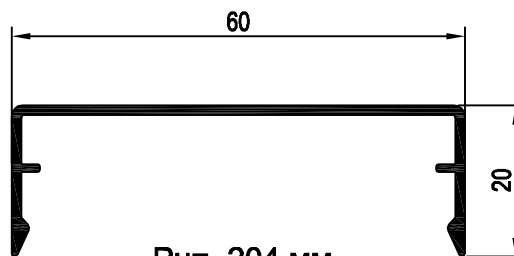

РН= 204 мм

90512

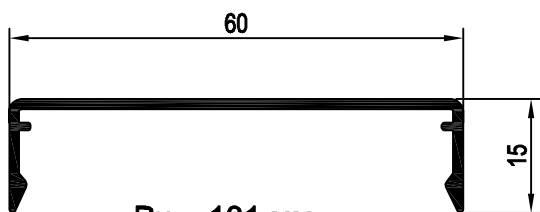

РН= 181 мм

90514

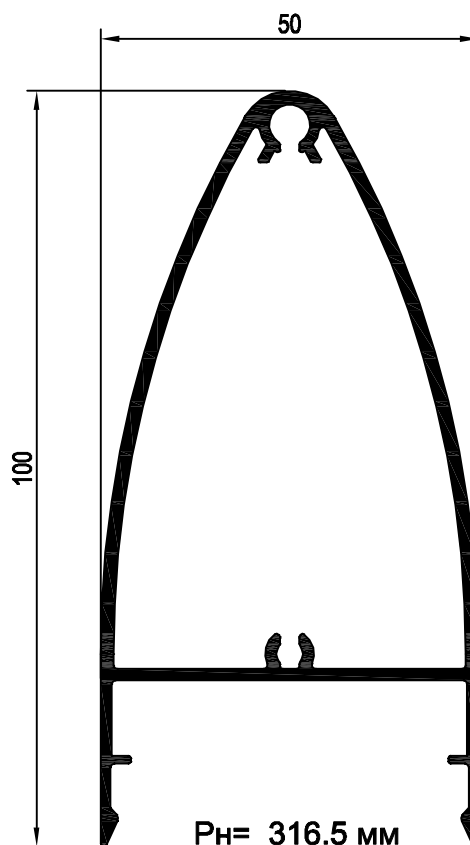

РН= 316.5 мм

90513

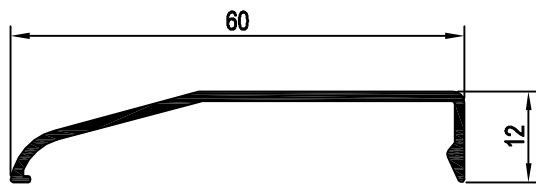

РН= 151.6 мм

90515

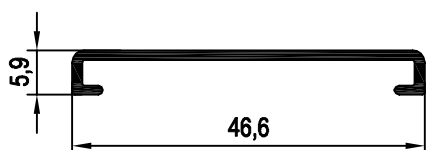

46,6

90516

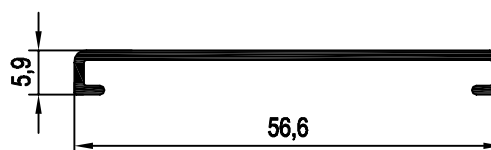

56,6





90600

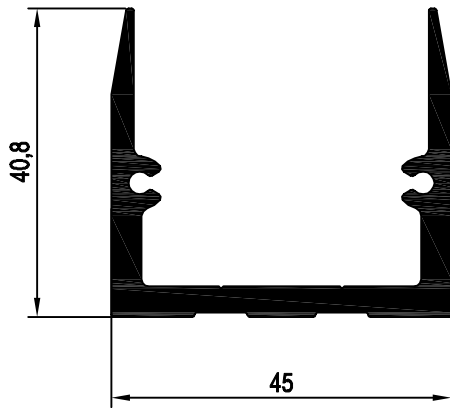

90604

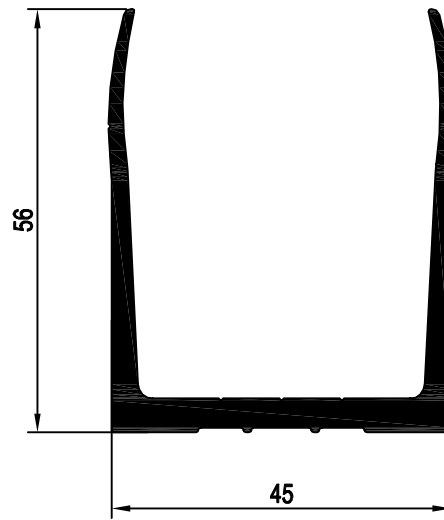

021A

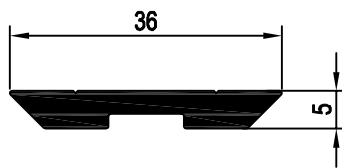

150513

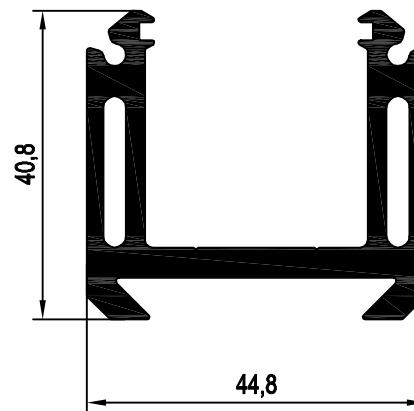

150512

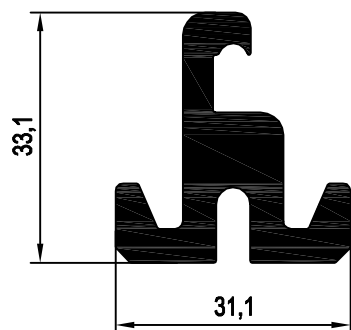

150521

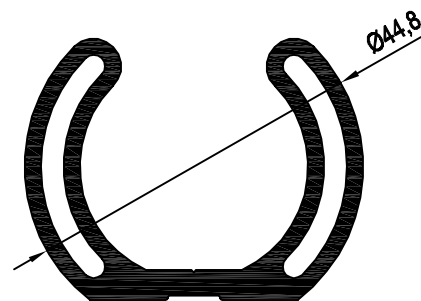



90602

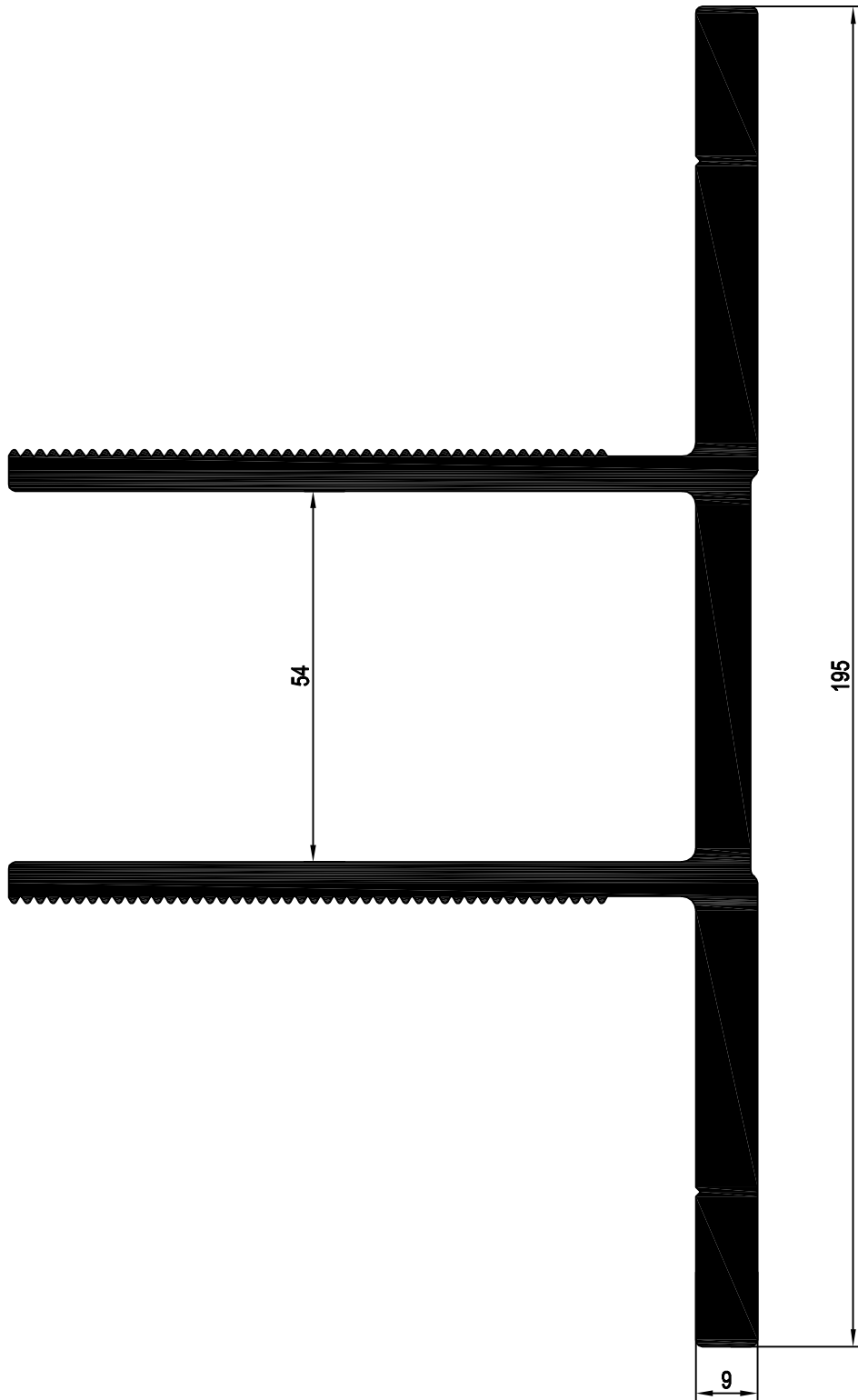

РН= 896 мм